

Physics - Section A

1. Identify the function which represents a non-periodic motion.

1. $e^{-\omega t}$
2. $\sin \omega t$
3. $\sin \omega t + \cos \omega t$
4. $\sin(\omega t + \pi/4)$

2. The magnetic field of a plane electromagnetic wave is given by

$\vec{B} = 3 \times 10^{-8} \cos(1.6 \times 10^3 x + 48 \times 10^{10} t) \hat{j}$, then the associated electric field will be:

1. $3 \times 10^{-8} \cos(1.6 \times 10^3 x + 48 \times 10^{10} t) \hat{i}$ V/m
2. $3 \times 10^{-8} \sin(1.6 \times 10^3 x + 48 \times 10^{10} t) \hat{i}$ V/m
3. $9 \sin(1.6 \times 10^3 x - 48 \times 10^{10} t) \hat{k}$ V/m
4. $9 \cos(1.6 \times 10^3 x + 48 \times 10^{10} t) \hat{k}$ V/m

3. The incorrect statement about the property of a Zener diode is:

1. Zener voltage remains constant at breakdown
2. It is designed to operate under reverse bias
3. Depletion region formed is very wide
4. p and n regions of zener diode are heavily doped

4. A cell of emf 4 V and internal resistance 0.5 Ω is connected to a 7.5 Ω external resistance. The terminal potential difference of the cell is:-

1. 3.75 V
2. 4.25 V
3. 4 V
4. 0.375 V

5. Given below are two statements:

Statement-I: In an ac circuit, the current through a capacitor leads the voltage across it.

Statement-II: In a.c. circuits containing pure capacitance only, the phase difference between the current and the voltage is π

In the light of the above statements, choose the most appropriate answer from the options given below:

1. Both Statement-I and Statement-II are correct
2. Both Statement-I and Statement-II are incorrect
3. Statement-I is correct but Statement-II is incorrect
4. Statement-I is incorrect but Statement-II is correct

6. The equivalent resistance of the infinite network given below is:

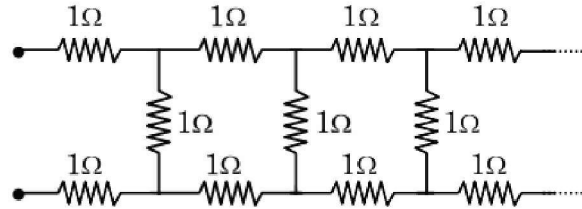

1. 2 Ω
2. $(1 + \sqrt{2}) \Omega$
3. $(1 + \sqrt{3}) \Omega$
4. $(1 + \sqrt{5}) \Omega$

7. A cricket ball is thrown by a player at a speed of 20 m/s in a direction 30° above the horizontal. The maximum height attained by the ball during its motion is: ($g = 10 \text{ m/s}^2$)

1. 5 m
2. 10 m
3. 20 m
4. 25 m

8. A closely packed coil having 1000 turns has an average radius 62.8 cm. If current carried by the wire of the coil is 1 A, the value of magnetic field produced at the centre of the coil will be (permeability of free space $= 4\pi \times 10^{-7} \text{ H/m}$) nearly:

1. 10^{-1} T
2. 10^{-2} T
3. 10^2 T
4. 10^{-3} T

9. An inductor of inductance 2 mH is connected to a 220 V, 50 Hz a.c. source. Let the inductive reactance in the circuit is X_1 . If a 220 V dc source replaces the ac source in the circuit, then the inductive reactance in the circuit is X_2 . X_1 and X_2 respectively are:

1. 6.28 Ω , zero
2. 6.28 Ω , infinity
3. 0.628 Ω , zero
4. 0.628 Ω , infinity

10. During a cloudy day, a primary and a secondary rainbow may be created, then the:

1. primary rainbow is due to double internal reflection and is formed above the secondary one.
2. primary rainbow is due to double internal reflection and is formed below the secondary one.
3. secondary rainbow is due to double internal reflection and is formed above the primary one.
4. secondary rainbow is due to single internal reflection and is formed above the primary one.

11. The light rays having photons of energy 4.2 eV are falling on a metal surface having a work function of 2.2 eV. The stopping potential of the surface is:

1. 2 eV
2. 2 V
3. 1.1 V
4. 6.4 V

12. In the diagram shown, the normal reaction force between 2 kg and 1 kg is (Consider the surface, to be smooth):

Given $g = 10 \text{ ms}^{-2}$

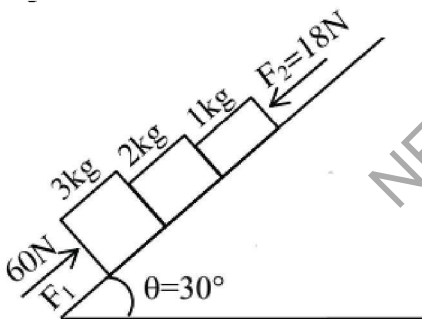

1. 25 N
2. 39 N
3. 6 N
4. 10 N

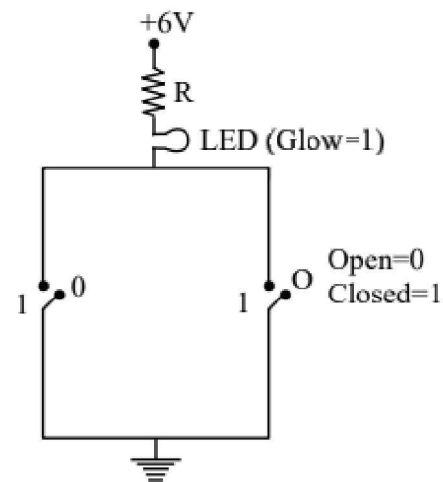

13.

Identify the equivalent logic gate represented by the given circuit:

1. OR
2. NOR
3. AND
4. NAND

14. Two copper vessels A and B have the same base area but of different shapes. A takes twice the volume of water as that B requires to fill upto a particular common height. Then the correct statement among the following is:

1. Pressure on the base area of vessels A and B is same.
2. Pressure on the base area of vessels A and B is not same.
3. Both vessels A and B weigh the same.
4. Vessel B weighs twice that of A.

15. The distance between the two plates of a parallel plate capacitor is doubled and the area of each plate is halved. If C is its initial capacitance, its final capacitance is equal to:

1. 2 C
2. C/2
3. 4 C
4. C/4

16. The terminal velocity of a copper ball of radius 5 mm falling through a tank of oil at room temperature is 10 cm s^{-1} . If the viscosity of oil at room temperature is $0.9 \text{ kg m}^{-1} \text{ s}^{-1}$, the viscous drag force is:

1. $8.48 \times 10^{-3} \text{ N}$
2. $8.48 \times 10^{-5} \text{ N}$
3. $4.23 \times 10^{-3} \text{ N}$
4. $4.23 \times 10^{-6} \text{ N}$

17. If $\vec{F} = 2\hat{i} + \hat{j} - \hat{k}$ and $\vec{r} = 3\hat{i} + 2\hat{j} - 2\hat{k}$, then the scalar and vector products of \vec{F} and \vec{r} have the magnitudes respectively as:

1. $5, \sqrt{3}$
2. $4, \sqrt{5}$
3. $10, \sqrt{2}$
4. $10, 2$

18. After passing through a polariser a linearly polarised light of intensity I is the incident on an analyser making an angle of 30° with that of the polariser. The intensity of light emitted from the analyser will be:

1. $\frac{I}{2}$
2. $\frac{I}{3}$
3. $\frac{3I}{4}$
4. $\frac{2I}{3}$

19. The restoring force of a spring with a block attached to the free end of the spring is represented by:

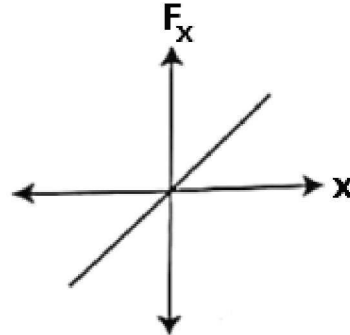

1.

2.

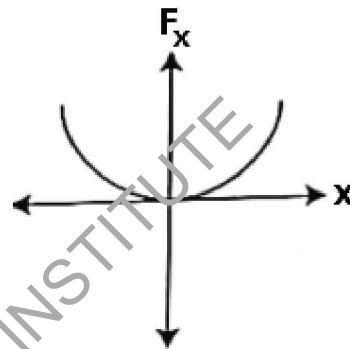

3.

4.

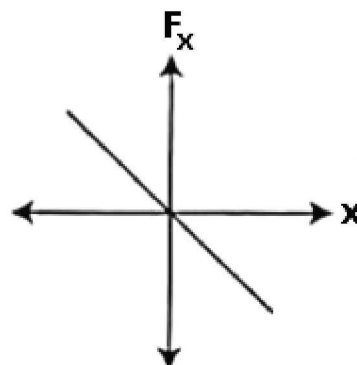
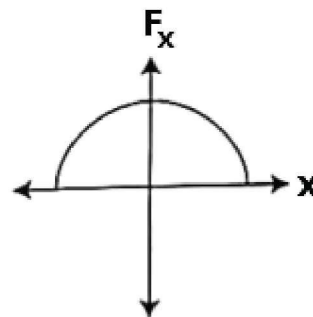

20. If the screen is moved away from the plane of the slits in a Young's double slit experiment, then the:

1. angular separation of the fringes increases
2. angular separation of the fringes decreases
3. linear separation of the fringes increases
4. linear separation of the fringes decreases

21. The effective capacitances of two capacitors are $3 \mu F$ and $16 \mu F$, when they are connected in series and parallel respectively. The capacitance of two capacitors are:

1. $10 \mu F, 6 \mu F$
2. $8 \mu F, 8 \mu F$
3. $12 \mu F, 4 \mu F$
4. $1.2 \mu F, 1.8 \mu F$

22. The distance covered by a body of mass 5 g having linear momentum 0.3 kg m/s in 5 s is:

1. 300 m
2. 30 m
3. 3 m
4. 0.3 m

23. A gravitational field is present in a region and a mass is shifted from A to B through different paths as shown. If W_1 , W_2 and W_3 represent the work done by the gravitational force along the respective paths, then:

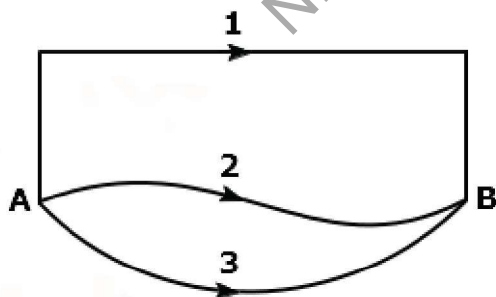

1. $W_1 = W_2 = W_3$
2. $W_1 > W_2 > W_3$
3. $W_1 > W_3 > W_2$
4. $W_1 < W_2 < W_3$

24. The reciprocal of resistance is:

1. reactance
2. mobility
3. conductivity
4. conductance

25. Given below are two statements: one is labelled as Assertion (A) and the other is labelled as Reason (R),

Assertion (A): When a fire cracker (rocket) explodes in mid air, its fragments fly in such a way that they continue moving in the same path, which the firecracker would have followed, had it not exploded.

Reason (R): Explosion of cracker (rocket) occurs due to internal forces only and no external force acts for this explosion.

In light of the above statements, choose the most appropriate answer from the options given below:

1. Both (A) and (R) are correct and (R) is the correct explanation of (A)
2. Both (A) and (R) are correct but (R) is not the correct explanation of (A)
3. (A) is correct but (R) is not correct
4. (A) is not correct but (R) is correct

26. The threshold frequency of a photoelectric metal is ν_0 . If light of frequency $4\nu_0$ is incident on this metal, then the maximum kinetic energy of emitted electrons will be:

1. $h\nu_0$
2. $2h\nu_0$
3. $3h\nu_0$
4. $4h\nu_0$

27. The ratio of the magnitude of the magnetic field and electric field intensity of a plane electromagnetic wave in free space of permeability μ_0 and permittivity ϵ_0 is (Given that c - velocity of light in free space)

1. c
2. $\frac{1}{c}$
3. $\frac{c}{\sqrt{\mu_0\epsilon_0}}$
4. $\frac{\sqrt{\mu_0\epsilon_0}}{c}$

28. The shape of the magnetic field lines due to an infinite long, straight current carrying conductor is:

1. a straight line
2. circular
3. elliptical
4. a plane

29. Match List-I with List-II:

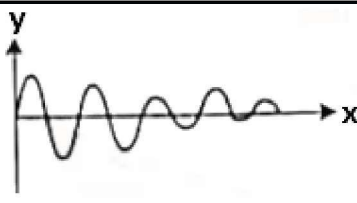
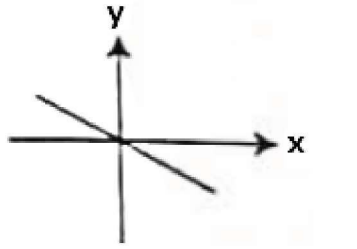
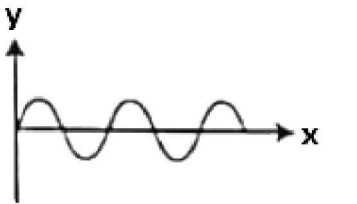
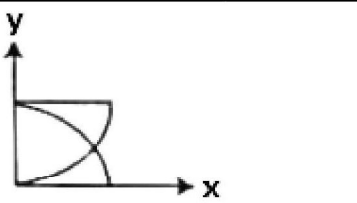
List-I (x-y graphs)		List-II (Situations)
(a) 	(i)	Total mechanical energy is conserved
(b) 	(ii)	Bob of a pendulum is oscillating under negligible air friction
(c) 	(iii)	Restoring force of a spring
(d) 	(iv)	Bob of a pendulum is oscillating along with air friction

Choose the correct answer from the options given below:

	(a)	(b)	(c)	(d)
1.	(iv)	(ii)	(iii)	(i)
2.	(iv)	(iii)	(ii)	(i)
3.	(i)	(iv)	(iii)	(ii)
4.	(iii)	(ii)	(i)	(iv)

30. Given below are two statements:

Statement-I: The law of radioactive decay states that the number of nuclei undergoing the decay per unit time is inversely proportional to the total number of nuclei in the sample.

Statement-II: The half life of a radionuclide is the sum of the life time of all nuclei, divided by the initial concentration of the nuclei at time $t = 0$.

In the light of the above statements, choose the most appropriate answer from the options given below:

1. Both Statement-I and Statement-II are correct
2. Both Statement-I and Statement-II are incorrect
3. Statement-I is correct but Statement-II is incorrect
4. Statement-I is incorrect but Statement-II is correct

31. An ideal gas follows a process described by the equation $PV^2 = C$ from the initial (P_1, V_1, T_1) to final (P_2, V_2, T_2) thermodynamics states, where C is a constant. Then:

1. If $P_1 > P_2$ then $T_1 < T_2$
2. If $V_2 > V_1$ then $T_2 > T_1$
3. If $V_2 > V_1$ then $T_2 < T_1$
4. If $P_1 > P_2$ then $V_1 > V_2$

32. A standard filament lamp consumes 100 W when connected to 200 V ac mains supply. The peak current through the bulb will be:

1. 0.707 A
2. 1 A
3. 1.414 A
4. 2 A

33. Let R_1 be the radius of the second stationary orbit and R_2 be the radius of the fourth stationary orbit of an electron in Bohr's model. The ratio $\frac{R_1}{R_2}$ is:

1. 0.25
2. 0.5
3. 2
4. 4

34. The physical quantity that has the same dimensional formula as pressure is:

1. Force
2. Momentum
3. Young's modulus of elasticity
4. Coefficient of viscosity

35. An energy of 484 J is spent in increasing the speed of a flywheel from 60 rpm to 360 rpm. The moment of inertia of the flywheel is:

1. 0.7 kg-m^2
2. 3.22 kg-m^2
3. 30.8 kg-m^2
4. 0.07 kg-m^2

Physics - Section B

36. The magnetic flux linked to a circular coil of radius R is:

$$\phi = 2t^3 + 4t^2 + 2t + 5Wb$$

The magnitude of induced emf in the coil at $t = 5 \text{ s}$ is:

1. 108 V
2. 197 V
3. 150 V
4. 192 V

37. An astronomical refracting telescope is being used by an observer to observe planets in normal adjustment. The focal lengths of the objective and eye piece used in the construction of the telescope are 20 m and 2 cm respectively. Consider the following statements about the telescope:

- (a) The distance between the objective and eye piece is 20.02 m
- (b) The magnification of the telescope is (-) 1000
- (c) The image of the planet is erect and diminished
- (d) The aperture of eye piece is smaller than that of objective

The correct statements are:

1. (a), (b) and (c)
2. (b), (c) and (d)
3. (c), (d) and (a)
4. (a), (b) and (d)

38. At any instant, two elements X_1 and X_2 have same number of radioactive atoms. If the decay constant of X_1 and X_2 are 10λ and λ respectively. Then the time when the ratio of their atoms becomes $\frac{1}{e}$ respectively will be:

1. $\frac{1}{11\lambda}$
2. $\frac{1}{9\lambda}$
3. $\frac{1}{6\lambda}$
4. $\frac{1}{5\lambda}$

39. Six charges $+q, -q, +q, -q, +q$ and $-q$ are fixed at the corners of a hexagon of side d as shown in the figure. The work done in bringing a charge q_0 to the centre of the hexagon from infinity is: (ϵ_0 —permittivity of free space)

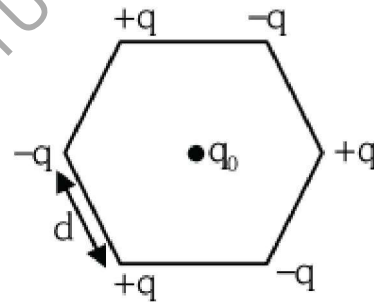

1. Zero
2. $\frac{-q^2}{4\pi\epsilon_0 d}$
3. $\frac{-q^2}{4\pi\epsilon_0 d} \left(3 - \frac{1}{\sqrt{2}} \right)$
4. $\frac{-q^2}{4\pi\epsilon_0 d} \left(6 - \frac{1}{\sqrt{2}} \right)$

40. An organ pipe filled with a gas at 27°C resonates at 400 Hz in its fundamental mode. If it is filled with the same gas at 90°C , the resonance frequency at the same mode will be:

1. 420 Hz
2. 440 Hz
3. 484 Hz
4. 512 Hz

41. The position-time (x-t) graph for positive acceleration is:

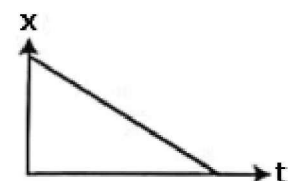
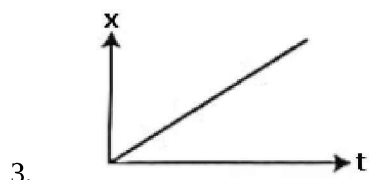
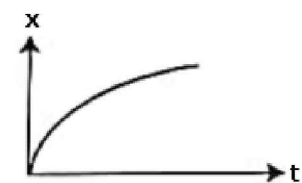
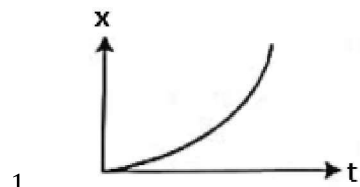

42. The collector current in a common base amplifier using n-p-n transistor is 24 mA. If 80% of the electrons released by the emitter is accepted by the collector, then the base current is numerically:

1. 6 mA and leaving the base
2. 3 mA and leaving the base
3. 6 mA and entering the base
4. 3 mA and entering the base

43. Three vessels of equal capacity have gases at the same temperature and pressure. The first vessel contains helium (monoatomic), the second contains fluorine (diatomic) and the third contains sulfur hexafluoride (polyatomic). The correct statement, among the following is:

1. All vessels contain unequal number of respective molecules
2. The root mean square speed of molecules is same in all three cases
3. The root mean square speed of helium is the largest
4. The root mean square speed of sulfur hexafluoride is the largest

44. In gravitational field, the gravitational potential is given by, $V = -\frac{K}{x} (J/kg)$. The gravitational field intensity at point (2, 0, 3)m is:

1. $+\frac{K}{2}$
2. $-\frac{K}{2}$
3. $-\frac{K}{4}$
4. $+\frac{K}{4}$

45. Two very long, straight, parallel conductor A and B carry current of 5 A and 10 A respectively and are at a distance of 10 cm from each other. The direction of current in two conductors is same. The force acting per unit length between two conductors is:

($\mu_0 = 4\pi \times 10^{-7}$ SI unit)

1. $2 \times 10^{-4} \text{ Nm}^{-1}$ and is attractive
2. $2 \times 10^{-4} \text{ Nm}^{-1}$ and is repulsive
3. $1 \times 10^{-4} \text{ Nm}^{-1}$ and is attractive
4. $1 \times 10^{-4} \text{ Nm}^{-1}$ and is repulsive

46. The magnetic field on the axis of a circular loop of radius 100 cm carrying current $I = \sqrt{2} \text{ A}$, at point 1 m away from the centre of the loop is given by:

1. $3.14 \times 10^{-7} \text{ T}$
2. $6.28 \times 10^{-7} \text{ T}$
3. $3.14 \times 10^{-4} \text{ T}$
4. $6.28 \times 10^{-4} \text{ T}$

47. Two rods one made of copper and other made of steel of the same length and same cross sectional area are joined together. The thermal conductivity of copper and steel are $385 \text{ J s}^{-1} \text{ m}^{-1}$ and $50 \text{ J s}^{-1} \text{ K}^{-1} \text{ m}^{-1}$ and $50 \text{ J s}^{-1} \text{ K}^{-1} \text{ m}^{-1}$ respectively. The free ends of copper and steel are held at 100°C and 0°C respectively. The temperature at the junction is, nearly:

1. 12°C
2. 50°C
3. 73°C
4. 88.5°C

48. The sliding contact C is at one fourth of the length of the potentiometer wire (AB) from A as shown in the circuit diagram. If the resistance of the wire AB is R_0 , then the potential drop (V) across the resistor R is:

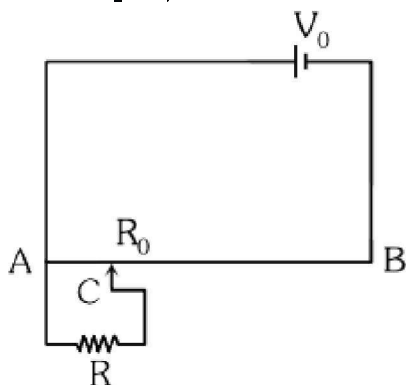

1. $\frac{4V_0R}{3R_0+16R}$
2. $\frac{4V_0R}{3R_0+R}$
3. $\frac{2V_0R}{4R_0+R}$
4. $\frac{2V_0R}{2R_0+3R}$

49. The ratio of coulomb's electrostatic force to the gravitational force between an electron and a proton separated by some distance is 2.4×10^{39} . The ratio of the proportionality constant, $K = \frac{1}{4\pi\epsilon_0}$ to the gravitational constant G is nearly (Given that the charge of the proton and electron each = 1.6×10^{-19} C, the mass of the electron = 9.11×10^{-31} kg, the mass of the proton = 1.67×10^{-27} kg):

1. 10^{20}
2. 10^{30}
3. 10^{40}
4. 10

50. The percentage error in the measurement of g is: (Given that

$$g = \frac{4\pi^2 L}{T^2}, L = (10 \pm 0.1) \text{ cm}, T = (100 \pm 1) \text{ s}$$

1. 2%
2. 5%
3. 3%
4. 7%

Chemistry - Section A

51. The correct order of bond angles in the following compounds/species is:

1. $\text{H}_2\text{O} < \text{NH}_3 < \text{NH}_4^+ < \text{CO}_2$
2. $\text{H}_2\text{O} < \text{NH}_4^+ < \text{NH}_3 < \text{CO}_2$
3. $\text{H}_2\text{O} < \text{NH}_4^+ = \text{NH}_3 < \text{CO}_2$
4. $\text{CO}_2 < \text{NH}_3 < \text{H}_2\text{O} < \text{NH}_4^+$

52. K_H value for some gases at the same temperature 'T' are given:

gas	$K_H/\text{k bar}$
Ar	40.3
CO_2	1.67
HCHO	1.83×10^{-5}
CH_4	0.413

where K_H is Henry's Law constant in water. The order of their solubility in water is :

1. $\text{Ar} < \text{CO}_2 < \text{CH}_4 < \text{HCHO}$
2. $\text{Ar} < \text{CH}_4 < \text{CO}_2 < \text{HCHO}$
3. $\text{HCHO} < \text{CO}_2 < \text{CH}_4 < \text{Ar}$
4. $\text{HCHO} < \text{CH}_4 < \text{CO}_2 < \text{Ar}$

53. Which of the following reactions is a part of the large scale industrial preparation of nitric acid?

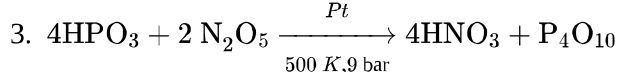
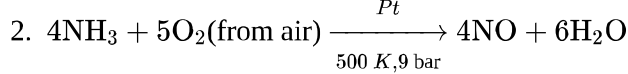
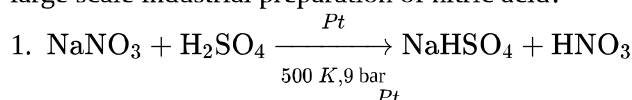

4.

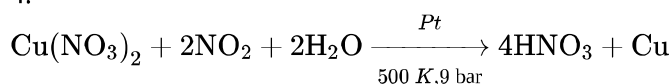

54. CaCl_2 and $\text{Ca}(\text{OCI})_2$ are components of:

1. gypsum
2. Portland cement
3. bleaching powder
4. lime water

55. The product formed from the following reaction sequence is:

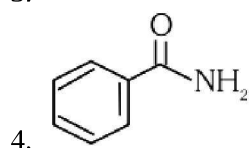
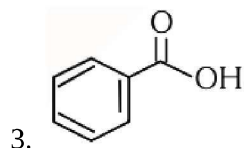
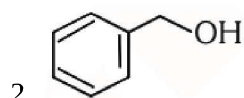
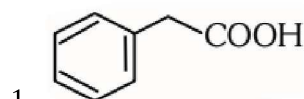
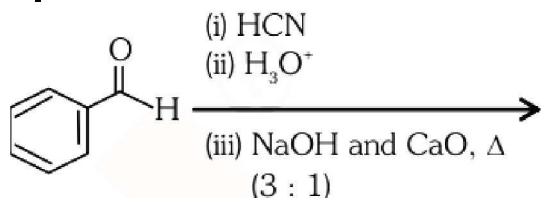

56. Match List - I with List - II :

List - I (Reaction)	List - II (Product formed)
(a) Gabriel synthesis	(i) Benzaldehyde
(b) Kolbe synthesis	(ii) Ethers
(c) Williamson synthesis	(iii) Primary amines
(d) Etard reaction	(iv) Salicylic acid

Choose the correct answer from the options given below:

	(a)	(b)	(c)	(d)
1.	(iii)	(i)	(ii)	(iv)
2.	(ii)	(iii)	(i)	(iv)
3.	(iv)	(iii)	(i)	(ii)
4.	(iii)	(iv)	(ii)	(i)

57. Match List - I with List - II

List - I	List - II
(a) Sodium laurylsulphate	(i) Toilet soap
(b) Cetyltrimethyl ammonium chloride	(ii) Non-ionic detergent
(c) Sodium stearate	(iii) Anionic detergent
(d) Polyethyleneglycyl stearate	(iv) Cationic detergent

Choose the correct answer from the options given below:

	(a)	(b)	(c)	(d)
1.	(iv)	(iii)	(i)	(ii)
2.	(i)	(iv)	(ii)	(iii)
3.	(iii)	(iv)	(i)	(ii)
4.	(iii)	(i)	(ii)	(iv)

58. Which of the following reactions is a decomposition redox reaction?

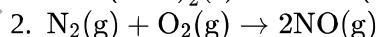
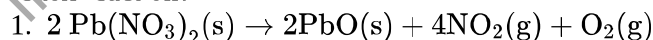

3.

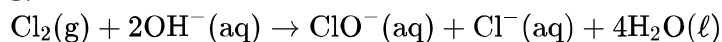

4.

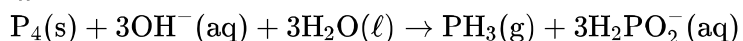

59. If first ionization enthalpies of element X and Y are 419 kJ mol^{-1} and 590 kJ mol^{-1} , respectively and second ionization enthalpies of X and Y are 3069 kJ mol^{-1} and 1145 kJ mol^{-1} , respectively. Then correct statement is :-

- X is an alkali metal and Y is an alkaline earth metal.
- X is an alkaline earth metal and Y is an alkali metal.
- Both X and Y are alkali metals.
- Both X and Y are alkaline earth metals.

60. Predict the order of reactivity of the following four isomers towards S_N2 reaction.

- (I) $CH_3CH_2CH_2CH_2Cl$
 (II) $CH_3CH_2CH(Cl)CH_3$
 (III) $(CH_3)_2CHCH_2Cl$
 (IV) $(CH_3)_3CCl$
- (IV) > (III) > (II) > (I)
 - (I) > (II) > (III) > (IV)
 - (I) > (III) > (II) > (IV)
 - (IV) > (II) > (III) > (I)

61. Match List-I with List-II :

List-I (Molecules)	List-II (Shape)
(a) NH_3	(i) Square pyramidal
(b) ClF_3	(ii) Trigonal bipyramidal
(c) PCl_5	(iii) Trigonal pyramidal
(d) BrF_5	(iv) T-shape

Choose the correct answer from the options given below:

	(a)	(b)	(c)	(d)
1.	(ii)	(iii)	(iv)	(i)
2.	(iii)	(iv)	(ii)	(i)
3.	(iv)	(iii)	(i)	(ii)
4.	(iii)	(iv)	(i)	(ii)

62. Which among the following is a thermoplastic polymer?

- Bakelite
- Polythene
- Urea-formaldehyde resin
- Melamine polymer

63. Match List-I with List-II :

List-I (Compounds)	List-II (Molecular formula)
(a) Borax	(i) $NaBO_2$
(b) Kernite	(ii) $Na_2B_4O_7 \cdot 4H_2O$
(c) Orthoboric acid	(iii) H_3BO_3
(d) Borax bead	(iv) $Na_2B_4O_7 \cdot 10H_2O$

Choose the correct answer from the options given below :

	(a)	(b)	(c)	(d)
1.	(iv)	(ii)	(iii)	(i)
2.	(ii)	(iv)	(iii)	(i)
3.	(iii)	(i)	(iv)	(ii)
4.	(i)	(iii)	(iv)	(ii)

64. Two half cell reactions are given below :

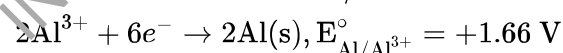
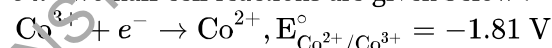

The standard EMF of a cell with feasible redox reaction will be:

- +7.09 V
- +0.15 V
- +3.47 V
- 3.47 V

65. The element used for welding metals with high melting points is:

- Cl_2
- H_2
- Ne
- He

66. $Na_2B_4O_7 \xrightarrow{\text{heat}} X + NaBO_2$
 in the above reaction the product "X" is :

- H_3BO_3
- B_2O_3
- $Na_2B_2O_5$
- NaB_3O_5

67. The correct order of first ionization enthalpy for the given four element is:

1. $C < N < F < O$
2. $C < N < O < F$
3. $C < O < N < F$
4. $C < F < N < O$

68. 0.01 M acetic acid solution is 1% ionised, then pH of this acetic acid solution is :

1. 3
2. 2
3. 4
4. 1

69. Shown below are adsorption isotherms for a gas 'X' at temperatures T_1 , T_2 and T_3 :

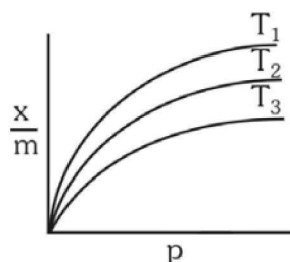

p and $\frac{x}{m}$ represent pressure and extent of adsorption, respectively. The correct order of temperatures for the given adsorption is:

1. $T_1 > T_2 > T_3$
2. $T_3 > T_2 > T_1$
3. $T_1 = T_2 = T_3$
4. $T_1 = T_2 > T_3$

70. The half-life of a first-order reaction is 2000 years. If the concentration after 8000 years is 0.02 M, then the initial concentration was :

1. 0.16 M
2. 0.32 M
3. 0.08 M
4. 0.04 M

71. One mole of an ideal gas at 300 K is expanded isothermally from 1 L to 10 L volume. ΔU for this process is (Use $R = 8.314 \text{ J K}^{-1} \text{ mol}^{-1}$)

1. 1260 J
2. 2520 J
3. 5040 J
4. 0 J

72. What is the hybridization shown by C_1 and C_2 carbons, respectively in the given compound?

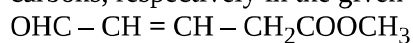

1. sp^2 and sp^3
2. sp^2 and sp^2
3. sp^3 and sp^2
4. sp^3 and sp^3

73. The density of the solution is 2.15 g mL^{-1} , then mass of 2.5 mL solution in correct significant figures is

1. $5375 \times 10^{-3} \text{ g}$
2. 5.4 g
3. 5.38 g
4. 53.75 g

74. Fluorine is a stronger oxidising agent than chlorine because :

- (a) F-F bond has a low enthalpy of dissociation.
- (b) Flouride ion (F^-) has high hydration enthalpy.
- (c) Electron gain enthalpy of fluorine is less negative than chlorine.
- (d) Fluorine has a very small size.

Choose the most appropriate answer from the options given :

1. (a) and (b) only
2. (a) and (c) only
3. (a) and (d) only
4. (b) and (c) only

75. Match List-I with List-II :

List-I (Complexes)	List-II (Types)
(a) $[\text{Co}(\text{NH}_3)_5\text{NO}_2]\text{Cl}_2$ and $[\text{Co}(\text{NH}_3)_5\text{ONO}]\text{Cl}_2$	(i) ionisation isomerism
(b) $[\text{Cr}(\text{NH}_3)_6][\text{Co}(\text{CN})_6]$ and $[\text{Cr}(\text{CN})_6][\text{Co}(\text{NH}_3)_6]$	(ii) coordination isomerism
(c) $[\text{Co}(\text{NH}_3)_5(\text{SO}_4)]\text{Br}$ and $[\text{Co}(\text{NH}_3)_5\text{Br}]\text{SO}_4$	(iii) linkage isomerism
(d) $[\text{Cr}(\text{H}_2\text{O})_6]\text{Cl}_3$ and $[\text{Cr}(\text{H}_2\text{O})_5\text{Cl}]\text{Cl}_2 \cdot \text{H}_2\text{O}$	(iv) solvate isomerism

Choose the correct answer from the options given below :

	(a)	(b)	(c)	(d)
1.	(iii)	(i)	(ii)	(iv)
2.	(ii)	(iii)	(iv)	(i)
3.	(iii)	(ii)	(i)	(iv)
4.	(iv)	(iii)	(ii)	(i)

76. The incorrect statement about denaturation of proteins is

1. It results due to change of temperature and/or pH.
2. It results in loss of biological activity of proteins.
3. A protein is formed from amino acids linked by peptide bonds.
4. Uncoiling of the helical structure takes place.

77. The product formed from the following reaction sequence is

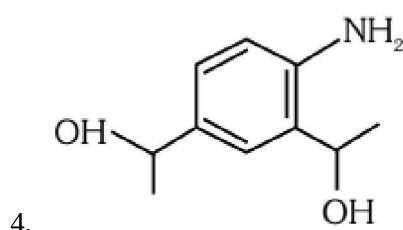
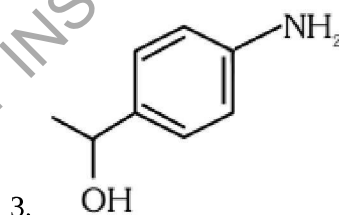
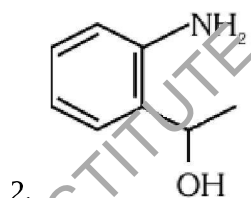
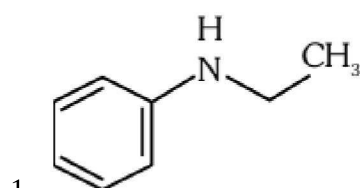
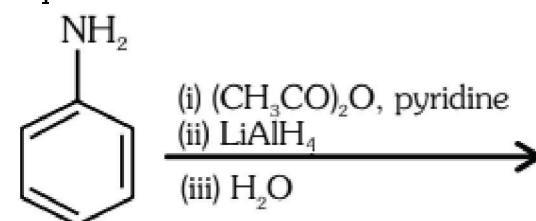

78. Match List-I with List-II :

List-I (Defects)	List-II (shown by)
(a) Frenkel defect	(i) non-ionic solids and density of the solid decreases.
(b) Schottky defect	(ii) non-ionic solids and density of the solid increases.
(c) Vacancy defect	(iii) ionic solids and density of the solid decreases.
(d) Interstitial defect	(iv) ionic solids and density of the solid remains constant.

Choose the correct answer from the options given below:

	(a)	(b)	(c)	(d)
1.	(i)	(ii)	(iii)	(iv)
2.	(i)	(iii)	(ii)	(iv)
3.	(iv)	(iii)	(ii)	(i)
4.	(iv)	(iii)	(i)	(ii)

79. Given below are two statements : one is labelled as Assertion (A) and the other is labelled as Reason (R).
Assertion (A): Chlorine is an electron withdrawing group but it is ortho, para directing in electrophilic aromatic substitution.

Reason (R): Inductive effect of chlorine destabilises the intermediate carbocation formed during the electrophilic substitution, however due to the more pronounced resonance effect, the halogen stabilises the carbocation at ortho and para positions.

In the light of the above statements, choose the most appropriate answer from the options given below :

- Both (A) and (R) are correct and (R) is the correct explanation of (A).
- Both (A) and (R) are correct but (R) is not the correct explanation of (A).
- (A) is correct but (R) is not correct.
- (A) is not correct but (R) is correct.

80. Which of the following reactions is not an example for nucleophilic addition – elimination reaction ?

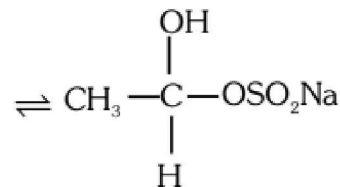

- $\text{CH}_3\text{CHO} + \text{NaHSO}_3$
- $\text{CH}_3\text{CHO} + \text{NH}_2\text{OH} \rightleftharpoons \text{CH}_3\text{CH} = \text{N}-\text{OH} + \text{H}_2\text{O}$
- $\text{CH}_3\text{CHO} + \text{C}_6\text{H}_5\text{NHNH}_2 \rightleftharpoons \text{CH}_3\text{CH} = \text{N}-\text{NHC}_6\text{H}_5 + \text{H}_2\text{O}$
- $\text{CH}_3\text{CHO} + \text{NH}_3 \rightleftharpoons \text{CH}_3\text{CH} = \text{NH} + \text{H}_2\text{O}$

81. Four gas cylinders containing He, N₂, CO₂ and NH₃ gases separately are gradually cooled from a temperature of 500 K. Which gas will liquify first? (Given T_C in K – He : 5.3, N₂ : 126, CO₂ : 304.1 and NH₃ : 405.5)

- He
- N₂
- CO₂
- NH₃

82. Decrease in size from left to right in actinoid series is greater and gradual than that in lanthanoid series due to :

- 4 f orbitals are penultimate
- 4 f orbitals have greater shielding effect
- 5 f orbitals have poor shielding effect
- 5 f orbitals have greater shielding effect

83. The decreasing order of boiling points of the following alkanes is :

- Heptane
- butane
- 2-methylbutane
- 2-methylpropane
- hexane

Choose the correct answer from the options given below :

- (a) > (c) > (e) > (d) > (b)
- (c) > (d) > (a) > (e) > (b)
- (a) > (e) > (b) > (c) > (d)
- (a) > (e) > (c) > (b) > (d)

84. Match the reagents (List-I) with the product (List-II) obtained from phenol.

List-I	List-II
(a) (i) NaOH (ii) CO ₂ (iii) H ⁺	(i) Benzoquinone
(b) (i) Aqueous NaOH + CHCl ₃ (ii) H ⁺	(ii) Benzene
(c) Zn dust, Δ	(iii) Salicylaldehyde
(d) Na ₂ Cr ₂ O ₇ , H ₂ SO ₄	(iv) Salicylic acid

Choose the correct answer from the options given below :

	(a)	(b)	(c)	(d)
1.	(iii)	(iv)	(i)	(ii)
2.	(ii)	(i)	(iv)	(iii)
3.	(iv)	(iii)	(ii)	(i)
4.	(iv)	(ii)	(i)	(iii)

85. Match List-I with List-II:

List-I (quantum number)	List-II (Orbital)
(a) n = 2, ℓ = 1	(i) 2s
(b) n = 3, ℓ = 2	(ii) 3s
(c) n = 3, ℓ = 0	(iii) 2p
(d) n = 2, ℓ = 0	(iv) 3d

Choose the correct answer from the options given below :

	(a)	(b)	(c)	(d)
1	(iii)	(iv)	(i)	(ii)
2	(iv)	(iii)	(i)	(ii)
3	(iv)	(iii)	(ii)	(i)
4	(iii)	(iv)	(ii)	(i)

Chemistry - Section B

86. Which one of the following is not a calcination reaction?

- $\text{ZnCO}_3 \xrightarrow{\Delta} \text{ZnO} + \text{CO}_2$
- $\text{Fe}_2\text{O}_3 \cdot x\text{H}_2\text{O} \xrightarrow{\Delta} \text{Fe}_2\text{O}_3 + x\text{H}_2\text{O}$
- $\text{CaCO}_3 \cdot \text{MgCO}_3 \xrightarrow{\Delta} \text{CaO} + \text{MgO} + 2\text{CO}_2$
- $\text{CaCO}_3 + 2\text{HCl} \xrightarrow{\Delta} \text{CaCl}_2 + \text{H}_2\text{O} + \text{CO}_2$

87. When electromagnetic radiation of wavelength 300 nm falls on the surface of a metal, electrons are emitted with the kinetic energy of $1.68 \times 10^5 \text{ J mol}^{-1}$. What is the minimum energy needed to remove an electron from the metal?

($h = 6.626 \times 10^{-34} \text{ Js}$, $c = 3 \times 10^8 \text{ ms}^{-1}$, $N_A = 6.022 \times 10^{23} \text{ mol}^{-1}$)

- $2.31 \times 10^6 \text{ J mol}^{-1}$
- $3.84 \times 10^4 \text{ J mol}^{-1}$
- $3.84 \times 10^{-19} \text{ J mol}^{-1}$
- $2.31 \times 10^5 \text{ J mol}^{-1}$

88. For a chemical reaction

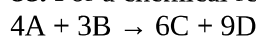

rate of formation of C is $6 \times 10^{-2} \text{ mol L}^{-1} \text{ s}^{-1}$ and rate of disappearance of A is $4 \times 10^{-2} \text{ mol L}^{-1} \text{ s}^{-1}$. The rate of reaction and amount of B consumed in interval of 10 seconds, respectively will be:

- $1 \times 10^{-2} \text{ mol L}^{-1} \text{ s}^{-1}$ and $30 \times 10^{-2} \text{ mol L}^{-1}$
- $10 \times 10^{-2} \text{ mol L}^{-1} \text{ s}^{-1}$ and $10 \times 10^{-2} \text{ mol L}^{-1}$
- $1 \times 10^{-2} \text{ mol L}^{-1} \text{ s}^{-1}$ and $10 \times 10^{-2} \text{ mol L}^{-1}$
- $10 \times 10^{-2} \text{ mol L}^{-1} \text{ s}^{-1}$ and $30 \times 10^{-2} \text{ mol L}^{-1}$

89. The incorrect method for the synthesis of alkenes is:

- treatment of alkynes with Na in liquid NH₃
- heating alkyl halides with alcoholic KOH
- treating alkyl halides in aqueous KOH solution
- treating vicinal dihalides with Zn metal

90. The incorrect method to synthesize benzaldehyde is:

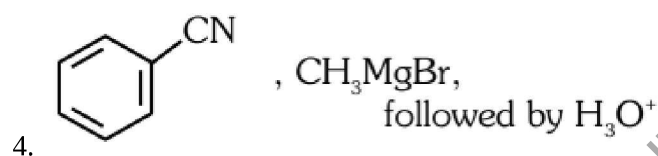
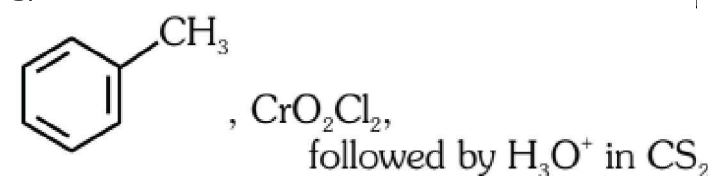
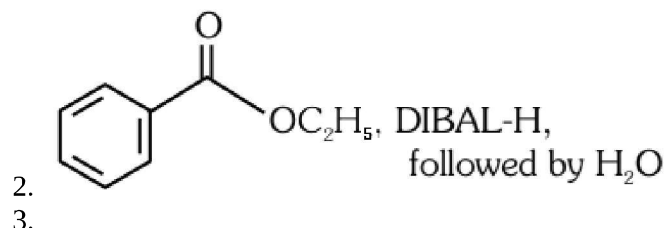
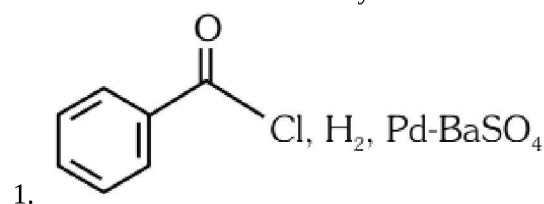

91. What fraction of Fe exists as Fe(III) in Fe_{0.96}O?
(Consider Fe_{0.96} to be made up of Fe(II) and Fe(III)
only)

1. $\frac{1}{12}$
2. 0.08
3. $\frac{1}{16}$
4. $\frac{1}{20}$

92. Given below are two statements : one is labelled as Assertion (A) and the other is labelled as Reason (R).

Assertion (A) : The metal carbon bond in metal carbonyls possesses both σ and π character.

Reason (R) : The ligand to metal bond is a π bond and metal to ligand bond is a σ bond.

In the light of the above statements, choose the most appropriate answer from the options given below :

1. Both (A) and (R) are correct and (R) is the correct explanation of (A).
2. Both (A) and (R) are correct but (R) is not the correct explanation of (A).
3. (A) is correct but (R) is not correct.
4. (A) is not correct but (R) is correct.

93. Which one of the following reaction sequence is incorrect method to prepare phenol?

1. Aniline, NaNO₂ + HCl, H₂O, heating

2. Cumene, O₂, H₃O⁺

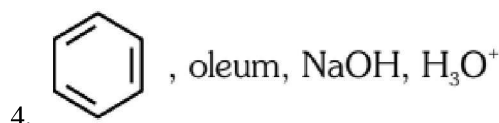
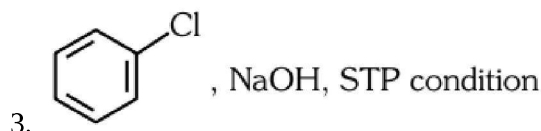

94. A vessel contains 3.2 g of dioxygen gas at STP (273.15 K and 1 atm pressure). The gas is now transferred to another vessel at constant temperature, where pressure becomes one third of the original pressure. The volume of new vessel in L is:

(Given - molar volume at STP is 22.4 L)

1. 6.72
2. 2.24
3. 22.4
4. 67.2

95. Match List-I with List-II :

List-I	List-II
(a) Biochemical oxygen demand	(i) Oxidising mixture
(b) Photochemical smog	(ii) Polar stratospheric cloud
(c) Classical smog	(iii) organic matter in water
(d) Ozone layer depletion	(iv) reducing mixture

Choose the correct answer from the options given below:

	(a)	(b)	(c)	(d)
1.	(i)	(iv)	(ii)	(iii)
2.	(iii)	(iv)	(i)	(ii)
3.	(iii)	(i)	(iv)	(ii)
4.	(iv)	(iii)	(ii)	(i)

96. The products A and B in the following reaction sequence are :

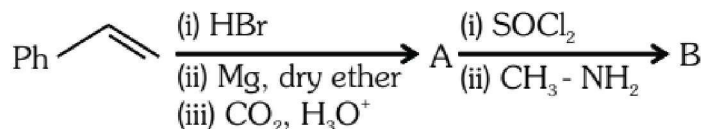

1.

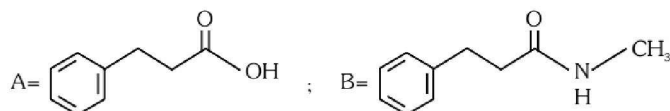

2.

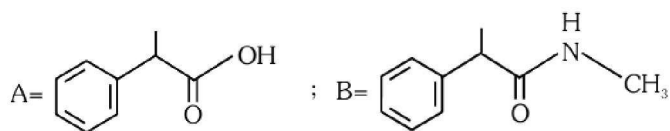

3.

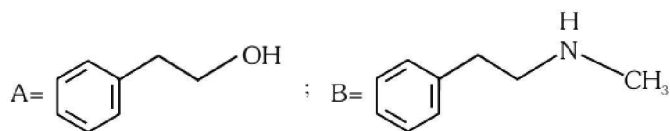

4.

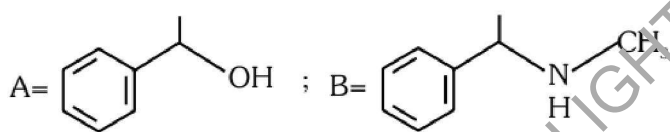

97. Given below are two statements:

Statement I: Cr^{2+} is oxidising and Mn^{3+} is reducing in nature.

Statement II: Sc^{3+} compounds are repelled by the applied magnetic field.

In the light of the above statements, choose the most appropriate answer from the options given below:

- Both Statement I and Statement II are correct
- Both Statement I and Statement II are incorrect
- Statement I is correct but Statement II is incorrect
- Statement I is incorrect but Statement II is correct

98. K_p for the following reaction is 3.0 at 1000 K.

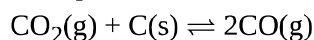

What will be the value of K_C for the reaction at the same temperature?

(Given - $R = 0.083 \text{ L bar K}^{-1} \text{ mol}^{-1}$)

- 0.36
- 3.6×10^{-2}
- 3.6×10^{-3}
- 3.6

99. Standard electrode potential for the cell with cell reaction

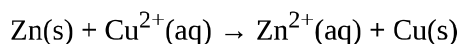

is 1.1 V. Calculate the standard gibbs energy change for the cell reaction.

(Given $F = 96487 \text{ C mol}^{-1}$)

- $-200.27 \text{ kJ mol}^{-1}$
- $-212.27 \text{ kJ mol}^{-1}$
- $-212.27 \text{ J mol}^{-1}$
- $-200.27 \text{ J mol}^{-1}$

100. Which of the following is the most stable carbocation?

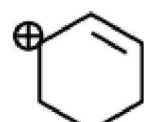
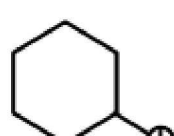
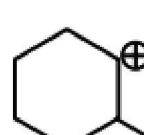
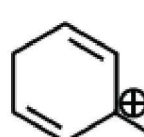
- 
- 
- 
- 

Biology - 1 - Section A

101. Which stage of meiosis can last for months or years in the oocytes of some vertebrates?

1. Leptotene
2. Pachytene
3. Diplotene
4. Diakinesis

102. When one CO₂ molecule is fixed as one molecule of triose phosphate, which of the following photochemically made, high energy chemical intermediates are used in the reduction phase?

1. 1 ATP + 1 NADPH
2. 1 ATP + 2 NADPH
3. 2 ATP + 1 NADPH
4. 2 ATP + 2 NADPH

103. In lac operon, z gene codes for :

1. β -galactosidase
2. Permease
3. Repressor
4. Transacetylase

104. Initiation of lateral roots and vascular cambium during secondary growth takes place in cells of :

1. Epiblema
2. Cortex
3. Endodermis
4. Pericycle

105. Match List-I with List -II:

List- I	List-II
(a) Adenine	(i) Pigment
(b) Anthocyanin	(ii) Polysaccharide
(c) Chitin	(iii) Alkaloid
(d) Codeine	(iv) Purine

Choose the correct answer from the options given below :

	(a)	(b)	(c)	(d)
1.	(iv)	(i)	(ii)	(iii)
2.	(iv)	(iii)	(ii)	(i)
3.	(iii)	(i)	(iv)	(ii)
4.	(i)	(iv)	(iii)	(ii)

106. Match List-I with List- II

List- I	List -II
(a) In lac operon i gene codes for	(i) transacetylase
(b) In lac operon z gene codes for	(ii) permease
(c) In lac operon y gene codes for	(iii) β -galactosidase
(d) In lac operon a gene codes for	(iv) Repressor

Choose the correct answer from the options given below :

	(a)	(b)	(c)	(d)
1.	(iii)	(ii)	(i)	(iv)
2.	(iv)	(iii)	(ii)	(i)
3.	(iv)	(i)	(iii)	(ii)
4.	(iii)	(i)	(iv)	(ii)

107. Match List-I with List-II

List-I	List-II
(a) Chlamydomonas	(i) Moss
(b) Cycas	(ii) Pteridophyte
(c) Selaginella	(iii) Alga
(d) Sphagnum	(iv) Gymnosperm

Choose the correct answer from the options given below :

	(a)	(b)	(c)	(d)
1	(iii)	(i)	(ii)	(iv)
2	(iii)	(iv)	(ii)	(i)
3	(iii)	(ii)	(i)	(iv)
4	(ii)	(iii)	(i)	(iv)

108. Given below are two statements :

Statement I : DNA polymerases catalyse polymerisation only in one direction, that is 5' → 3'

Statement II : During replication of DNA, on one strand the replication is continuous while on other strand it is discontinuous.

In the light of the above statements, choose the correct answer from the options given below :

- Both Statement I and Statement II are correct
- Both Statement I and Statement II are incorrect
- Statement I is correct but Statement II is incorrect
- Statement I is incorrect but Statement II is correct

109. The Floral Diagram represents which one of the following families?

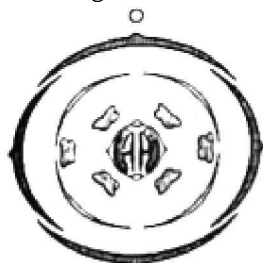

- Fabaceae
- Brassicaceae
- Solanaceae
- Liliaceae

110. The pioneer species in a hydrarch succession are :

- Free-floating angiosperms
- Submerged rooted plants
- Phytoplanktons
- Filamentous algae

111. The number of time(s) decarboxylation of isocitrate occurs during single TCA cycle is :

- One
- Two
- Three
- Four

112. Given below are two statements :

Statement I : Sickle cell anaemia and Haemophilia are autosomal dominant traits .

Statement II : Sickle cell anaemia and Haemophilia are disorders of the blood.

In the light of the above statements, choose the correct answer from the options given below :

- Both Statement I and Statement II are correct
- Both Statement I and Statement II are incorrect
- Statement I is correct but Statement II is incorrect
- Statement I is incorrect but Statement II is correct

113. Given below are two statements one is labelled as Assertion (A) and the other is labelled as Reason (R).

Assertion (A) : When a particular restriction enzyme cuts strand of DNA, overhanging stretches or sticky ends are formed.

Reason (R) : Some restriction enzymes cut the strand of DNA a little away from the centre of palindromic site.

In the light of the above statements, choose the correct answer from the options given below :

- Both (A) and (R) are correct and (R) is the correct explanation of (A)
- Both (A) and (R) are correct but (R) is not the correct explanation of (A)
- (A) is correct but (R) is not correct
- (A) is not correct but (R) is correct

114. Give the correct descending order of organisms with reference to their estimated number found in Amazon forest.

- Plants
- Invertebrates
- Fishes
- Mammals
- Birds

Choose the correct answer from the options given below :

- (a) > (b) > (e) > (d) > (c)
- (a) > (c) > (d) > (b) > (e)
- (b) > (a) > (e) > (d) > (c)
- (b) > (a) > (c) > (e) > (d)

115. Match List-I with List-II

List-I	List-II
(a) Porins	(i) Pink coloured nodules
(b) leg haemoglobin	(ii) Lumen of thylakoid
(c) H ⁺ accumulation	(iii) Amphibolic pathway
(d) Respiration	(iv) Huge pores in outer membrane of mitochondria

Choose the correct answer from the options given below :

	(a)	(b)	(c)	(d)
1.	(ii)	(i)	(iv)	(iii)
2.	(iv)	(i)	(ii)	(iii)
3.	(iii)	(iv)	(ii)	(i)
4.	(ii)	(iv)	(i)	(iii)

116. Which of the following growth regulators is an adenine derivative ?

- Auxin
- Cytokinin
- Ethylene
- Abscisic acid

117. The type of tissue commonly found in the fruit wall of nuts is :

- Parenchyma
- Collenchyma
- Sclerenchyma
- Sclereid

118. The species that come to appear in bare area are called :

- Pioneer species
- Invasive species
- Competitive species
- Species of seral community

119. In general the egg apparatus of embryo sac in angiosperm consists of :

- One egg cell, two synergids, three antipodal cells, two Polar nuclei
- One egg cell, two synergids, two antipodal cells, three Polar nuclei
- One egg cell, three synergids, two antipodal cells, two Polar nuclei
- One egg cell, two synergids, two antipodal cells, two Polar nuclei

120. Match List-I with List-II

List-I	List-II
(a) Imbricate	(i) Calotropis
(b) Valvate	(ii) Cassia
(c) Vexillary	(iii) Cotton
(d) Twisted	(iv) Bean

Choose the correct answer from the options given below :

	(a)	(b)	(c)	(d)
1.	(ii)	(i)	(iii)	(iv)
2.	(ii)	(i)	(iv)	(iii)
3.	(ii)	(iv)	(iii)	(i)
4.	(i)	(iii)	(iv)	(ii)

121. All successions irrespective of the habitat proceed to which type of climax community ?

1. Xeric
2. Mesic
3. Hydrophytic
4. Edaphic

122. Separation of DNA, fragments is done by a technique known as :

1. Polymerase Chain Reaction
2. Recombinant technology
3. Southern blotting
4. Gel electrophoresis

123. The phenomenon by which the undividing parenchyma cells start to divide mitotically during plant tissue culture is called as :

1. Differentiation
2. Dedifferentiation
3. Redifferentiation
4. Secondary growth

124. In meiosis, crossing over and exchange of genetic material between homologous chromosomes are catalyzed by the enzyme.

1. Phosphorylase
2. Recombinase
3. Transferase
4. Polymerase

125. The 5-C compound formed during TCA cycle is :

1. α -ketoglutaric acid
2. Oxalo succinic acid
3. Succinic acid
4. Fumaric acid

126. When a carrier protein facilitates the movement of two molecules across the membrane in same direction, it is called :

1. Uniport
2. Transport
3. Antiport
4. Symport

127. The World Summit on sustainable development held in 2002 in Johannesburg, South Africa pledged for:

1. A significant reduction in the current rate of biodiversity loss.
2. Declaration of more biodiversity hotspots.
3. Increase in agricultural production
4. Collection and preservation of seeds of different genetic strains of commercially important plants.

128. Interfascicular cambium is present between :

1. Primary xylem and primary phloem
2. Pericycle and endodermis
3. Two vascular bundles
4. Secondary xylem and secondary phloem

129. The ascent of xylem sap in plants is mainly accomplished by the :

1. size of the stomatal aperture
2. distribution of stomata on the upper and lower epidermis
3. cohesion and adhesion between water molecules
4. root pressure

130. Which of the following statement is not correct?

1. Rhizome is a condensed form of stem
2. The apical bud in rhizome always remains above the ground
3. The rhizome is aerial with no distinct nodes and internodes
4. The rhizome is thick, prostrate and branched

131. To ensure that only the desired pollens fall on the stigma in artificial hybridization process :

- the female flower buds of plant producing unisexual flower need not be bagged.
- there is no need to emasculate unisexual flowers of selected female parent
- emasculated flowers are to be bagged immediately after cross pollination
- emasculated flowers are to be bagged after removal of anthers
- bisexual flowers, showing protogyny are never selected for cross

Choose the correct answer from the options given below :

- (a), (b) and (c) only
- (b), (c) and (d) only
- (b), (c) and (e) only
- (a), (d) and (e) only

132. The residual persistent part which forms the perisperm in the seeds of beet is :

- Calyx
- Endosperm
- Nucellus
- Integument

133. The chromosomal theory of inheritance was proposed by :

- Thomas Morgan
- Sutton and Boveri
- Gregor Mendel
- Robert Brown

134. Which of the following protects nitrogenase inside the root nodule of a leguminous plant ?

- Catalase
- leg haemoglobin
- Transaminase
- Glutamate dehydrogenase

135. The ability of plants to follow different pathways in response to environment leading to formation of different kinds of

structures is called :

- Redifferentiation
- Development
- Plasticity
- Differentiation

Biology - 1 - Section B

136. Which of the following pair represents free living nitrogen fixing aerobic bacteria?

- Rhizobium and Frankia
- Azotobacter and Beijernickia
- Anabaena and Rhodospirillum
- Pseudomonas and Thiobacillus

137. Match List-I with List-II :

List-I	List-II
(a) Sacred groves	(i) Alien species
(b) Zoological park	(ii) Release of large quantity of oxygen
(c) Nile perch	(iii) Ex-situ conservation
(d) Amazon forest	(iv) Khasi Hills in Meghalaya

Choose the correct answer from the options given below :

	(a)	(b)	(c)	(d)
1.	(iv)	(iii)	(i)	(ii)
2.	(ii)	(iv)	(i)	(iii)
3.	(iv)	(i)	(ii)	(iii)
4.	(iv)	(iii)	(ii)	(i)

138. Primary proteins are also called as polypeptides because :

- They are linear chains
- They are polymers of peptide monomers
- Successive amino acids are joined by peptide bonds
- They can assume many conformations

139. Match List-I with List-II :

List I	List II
(a) Gene gun	(i) Replacement of a faulty gene by a normal healthy gene
(b) Gene therapy	(ii) Used for transfer of gene
(c) Gene cloning	(iii) Total DNA in the cells of an organism
(d) Genome	(iv) To obtain identical copies of a particular DNA molecule

Choose the correct answer from the options given below :

	(a)	(b)	(c)	(d)
1.	(ii)	(i)	(iv)	(iii)
2.	(i)	(iii)	(ii)	(iv)
3.	(iv)	(i)	(iii)	(ii)
4.	(ii)	(iii)	(iv)	(i)

140. Match List-I with List-II

List-I	List-II
(a) Bacteriophage $\phi \times 174$	(i) 48502 base pairs
(b) Bacteriophage lambda	(ii) 5386 nucleotides
(c) Escherichia coli	(iii) 3.3×10^9 base pairs
(d) Haploid content human DNA	(iv) 4.6×10^6 base pairs of

Choose the correct answer from the options given below:

	(a)	(b)	(c)	(d)
1.	(i)	(ii)	(iii)	(iv)
2.	(ii)	(iv)	(i)	(iii)
3.	(ii)	(i)	(iv)	(iii)
4.	(i)	(ii)	(iv)	(iii)

141. Which of the following can be expected if scientists succeed in introducing apomictic gene into hybrid varieties of crops ?

1. Polyembryony will be seen and each seed will produce many plantlets
2. Seeds of hybrid plants will show longer dormancy
3. Farmers can keep on using the seeds produced by the hybrids to raise new crop year after year
4. There will be segregation of the desired characters only in the progeny

142. Read the following statements and identify the characters related to the alga shown in the diagram:

- (a) It is a member of Chlorophyceae
- (b) Food is stored in the form of starch
- (c) It is a monoecious plant showing oogonium and antheridium
- (d) Food is stored in the form of laminarin or mannitol
- (e) It shows dominance of pigments chlorophyll a, c and Fucoxanthin.

Choose the correct answer from the options given below



1. (a) and (b) only
2. (a), (b) and (c) only
3. (a), (c) and (d) only
4. (c), (d) and (e) only

143. Frugivorous birds are found in large numbers in tropical forests mainly because of :

1. lack of niche specialisation
2. higher annual rainfall
3. availability of fruits throughout the year
4. temperature conducive for their breeding

144. Which type of substance would face difficulty to pass through the cell membrane?

1. Substance with hydrophobic moiety
2. Substance with hydrophilic moiety
3. All substance irrespective of hydrophobic and hydrophilic moiety
4. Substance soluble in lipids

145. Identify the correct statements regarding chemiosmotic hypothesis :

- (a) Splitting of the water molecule takes place on the inner side of the membrane.
- (b) Protons accumulate within the lumen of the thylakoids.
- (c) Primary acceptor of electron transfers the electrons to an electron carrier.
- (d) NADP reductase enzyme is located on the stroma side of the membrane.
- (e) Protons increase in number in stroma.

Choose the correct answer from the options given below:

1. (a), (b) and (e)
2. (a), (b) and (d)
3. (b), (c) and (d)
4. (b), (c) and (e)

146. If a female individual is with small round head, furrowed tongue, partially open mouth and broad palm with characteristic palm crease. Also the physical, psychomotor and mental development is retarded. The karyotype analysis of such an individual will show :

1. 47 chromosomes with XXY sex chromosomes
2. 45 chromosomes with XO sex chromosomes
3. 47 chromosomes with XYY sex chromosomes
4. Trisomy of chromosome 21

147. Identify the correct sequence of events during Prophase I of meiosis :

- (a) Synapsis of homologous chromosomes
- (b) Chromosomes become gradually visible under microscope
- (c) Crossing over between non-sister chromatids of homologous chromosomes
- (d) Terminalisation of chiasmata
- (e) Dissolution of synaptonemal complex

Choose the correct answer from the options given below :

1. (a), (b), (c), (d), (e)
2. (b), (c), (d), (e), (a)
3. (b), (a), (c), (e), (d)
4. (a), (c), (d), (e), (b)

148. The enzyme (a) is needed for isolating genetic material from plant cells and enzyme (b) for isolating genetic material from fungus. Choose the correct pair of options from the following :

1. (a) Cellulase (b) Protease
2. (a) Cellulase (b) Chitinase
3. (a) Chitinase (b) Lipase
4. (a) Cellulase (b) Lipase

149. Match the List-I with List-II

List-I	List-II
(a) Carbon dissolved in oceans	(i) 55 billion tons
(b) Annual fixation of carbon through photosynthesis	(ii) 71%
(c) PAR captured by plants	(iii) 4×10^3 kg
(d) Productivity of oceans	(iv) 2 to 10%

Choose the correct answer from the options given below :

	(a)	(b)	(c)	(d)
1.	(ii)	(iv)	(iii)	(i)
2.	(iii)	(iv)	(ii)	(i)
3.	(ii)	(iii)	(iv)	(i)
4.	(iii)	(ii)	(i)	(iv)

150. What is the expected percentage of F₂ progeny with yellow and inflated pod in dihybrid cross experiment involving pea plants with green coloured, inflated pod and yellow coloured constricted pod ?

1. 100%
2. 56.25%
3. 18.75 %
- 4 9%

Biology - 2 - Section A

151. Pathogenic bacteria gain resistance to antibiotics due to changes in their :

1. Cosmids
2. Plasmids
3. Nucleus
4. Nucleoid

152. Milk of transgenic 'Cow Rosie' was nutritionally more balanced product for human babies than natural cow milk because it contained:

1. Human protein α -1-antitrypsin
2. Human alpha-lactalbumin
3. Human insulin-like growth factor
4. Human enzyme Adenosine Deaminase (ADA)

153. If the pH in lysosomes is increased to alkaline, what will be the outcome?

1. Hydrolytic enzymes will function more efficiently
2. Hydrolytic enzymes will become inactive
3. Lysosomal enzymes will be released into the cytoplasm
4. Lysosomal enzymes will be more active

154. Choose the incorrect enzymatic reaction:

1. $Maltose \xrightarrow{\text{Maltase}} Glucose + Galactose$
2. $Sucrose \xrightarrow{\text{sucrase}} Glucose + Fructose$
3. $Lactose \xrightarrow{\text{Lactase}} Glucose + Galactose$
4. $Dipeptides \xrightarrow{\text{Dipeptidases}} Amino\ acids$

155. Which of the following reasons is mainly responsible for graft rejection in transplantation of organs ?

1. Inability of recipient to differentiate between 'self and 'non-self' tissues/cells
2. Humoral immune response only
3. Auto-immune response
4. Cell-mediated response

156. If DNA contained sulphur instead of phosphorus and proteins contained phosphorus instead of sulfur, what would have been the outcome of Hershey and Chase experiment?

1. No radioactive sulfur in bacterial cells
2. Both radioactive sulfur and phosphorus in bacterial cells
3. Radioactive sulfur in bacterial cells
4. Radioactive phosphorus in bacterial cells

157. Two butterfly species are competing for the same nectar of a flower in a garden. To survive and coexist together, they may avoid competition in the same garden by:

1. feeding at the same time
2. choosing different foraging patterns
3. increasing time spent on attacking each other
4. predated on each other

158. Mad cow disease in cattle and Cr Jacob disease in humans are due to infection by _____.

1. Bacterium
2. Virus
3. Viroid
4. Prion

159. Which of the following is not an Intra Uterine Device?

1. Progestogens
2. Multiload 375
3. Lippes loop
4. Progestasert

160. Match List-I with List-II

List-I	List-II
(a) Chlamydomonas	(i) Conidia
(b) Penicillium	(ii) Zoospores
(c) Hydra	(iii) Gemmules
(d) Sponge	(iv) Buds

Choose the correct answer from the options given below:

	(a)	(b)	(c)	(d)
1.	(i)	(iv)	(iii)	(ii)
2.	(ii)	(i)	(iv)	(iii)
3.	(iii)	(ii)	(i)	(iv)
4.	(iv)	(iii)	(ii)	(i)

161. According to the sliding filament theory:

1. Actin and myosin filaments slide over each other to increase the length of the sarcomere.
2. Length of A-band does not change.
3. I-band increases in length
4. The actin filaments slide away from A-band resulting in shortening of sarcomere

162. The amount of biomass or organic matter produced per unit area over a time period by plants during photosynthesis is called:

1. Secondary production
2. Primary production
3. Gross primary production
4. Net primary production

163. Given below are two statements:

Statement I : Amino acids have a property of ionizable nature of $-NH_2$ and $-COOH$ groups, hence have different structures at different pH. Statement II : Amino acids can exist as Zwitterionic form at acidic and basic pH.

In the light of the above statements, choose the most appropriate answer from the options given below:

1. Both Statement I and Statement II are correct
2. Both Statement I and Statement II are Incorrect
3. Statement I is correct but Statement II is incorrect
4. Statement I is incorrect but Statement II is correct

164. Which of the following types of epithelium is present in the bronchioles and Fallopian tubes?

1. Simple squamous epithelium
2. Simple columnar epithelium
3. Ciliated epithelium
4. Stratified squamous epithelium

165. Western Ghats have a large number of plants and animal species that are not found any where else. Which of the following term is used to notify such species?

1. Threatened species
2. Keystone species
3. Endemic species
4. Vulnerable species

166. Gout is a type of disorder which leads to:

1. Inflammation of joints due to accumulation of uric acid crystals
2. Weakening of bones due to decreased bone mass
3. Inflammation of joints due to cartilage degeneration
4. Weakening of bones due to low calcium level

167. Which of the following statements are correct with respect to vital capacity?

- (a) It includes ERV, TV and IRV
- (b) Total volume of air a person can inspire after a normal expiration
- (c) The maximum volume of air a person can breathe in after forced expiration
- (d) It includes ERV, RV and IRV.
- (e) The maximum volume of air a person can breath out after a forced inspiration.

Choose the most appropriate answer from the options given below:

1. (b), (d) and (e)
2. (a), (c) and (d)
3. (a), (c) and (e)
4. (a) and (e)

168. A unique vascular connection between the digestive tract and liver is called _____ .

1. Hepato-pancreatic system
2. Hepatic portal system
3. Renal portal system
4. Hepato-cystic system

169. Match List-I with List-II regarding the organs of cockroach:

List I	List II
(a) Crop	(i) grinding the food particles
(b) Proventriculus	(ii) secretion of digestive juice
(c) Hepatic caecae	(iii) removal of nitrogenous waste
(d) Malpighian tubules	(iv) storage of food

Choose the correct answer from the options given below:

	(a)	(b)	(c)	(d)
1.	(iv)	(i)	(ii)	(iii)
2.	(iii)	(ii)	(i)	(iv)
3.	(ii)	(iv)	(i)	(iii)
4.	(i)	(iv)	(iii)	(ii)

170. Given below are two statements: one is labelled as Assertion (A) and the other is labelled as Reason (R)
Assertion (A) : Spirulina is a microbe that can be used for reducing environmental pollution.

Reason (R) : Spirulina is a rich source of protein, carbohydrates, fats, minerals and vitamins.

In the light of the above statements, choose the most appropriate answer from the options given below:

- Both (A) and (R) are correct and (R) is the correct explanation of (A)
- Both (A) and (R) are correct but (R) is not the correct explanation of (A)
- (A) is correct but (R) is not correct
- (A) is not correct but (R) is correct

171. Panspermia, an idea that is still a favourite for some astronomers, means :

- Creation of life from dead and decaying matter
- Creation of life from chemicals
- Origin of sperm in human testes
- Transfer of spores as unit of life from other planets of Earth

172. Arrange the components of mammary gland. (from proximal to distal)

- Mammary duct
- Lactiferous duct
- Alveoli
- Mammary ampulla
- Mammary tubules

Choose the most appropriate answer from the options given below :

- (c) → (a) → (d) → (e) → (b)
- (b) → (c) → (e) → (d) → (a)
- (c) → (e) → (a) → (d) → (b)
- (e) → (c) → (d) → (b) → (a)

173. Select the incorrect match regarding the symbols used in Pedigree analysis:

(1)  - Sex unspecified

(2)  - Affected individual

(3)  - Consanguineous mating

(4)  - Parent with male child affected with disease

174. Why CNG is considered better fuel than diesel?

- It can not be adulterated
- It takes less time to fill the fuel tank
- It burns more efficiently
- It is cheaper
- It is less inflammable.

Choose the most appropriate answer from the options given below

- (a), (b), (c), (e) only
- (a), (c), (d) only
- (a), (b), (d), (e) only
- (c), (d), (e) only

175. Which of the following methods is not commonly used for introducing foreign DNA into the plant cell?

- Agrobacterium mediated transformation
- Gene gun
- 'Disarmed pathogen' vectors
- Bacteriophages

176. Identify the region of human brain which has pneumotaxic centre that alters respiratory rate by reducing the duration of inspiration.

1. Medulla
2. Pons
3. Thalamus
4. Cerebrum

177. How many secondary spermatocytes are required to form 400 million spermatozoa ?

1. 50 million
2. 100 million
3. 200 million
4. 400 million

178. Choose the correct statement about a muscular tissue :

1. Skeletal muscle fibres are uninucleated and found in parallel bundles.
2. Intercalated discs allow the cardiac muscle cells to contract as a unit.
3. The walls of blood vessels are made up of columnar epithelium.
4. Smooth muscles are multinucleated and involuntary.

179. Given below are two statements : one is labelled as Assertion (A) and the other is labelled as Reason (R).

Assertion (A) : FSH which interacts with membrane bound receptors does not enter the target cell.

Reason (R) : Binding of FSH to its receptors generates second messenger (cyclic AMP) for its biochemical and physiological responses.

In the light of the above statements, choose the most appropriate answer from the options given below ;

1. Both (A) and (R) are correct and (R) is the correct explanation of (A)
2. Both (A) and (R) are correct but (R) is not the correct explanation of (A)
3. (A) is correct but (R) is not correct
4. (A) is not correct but (R) is correct

180. Which of the following animals has three chambered heart?

1. Scoliodon
2. Hippocampus
3. Chelone
4. Pteropus

181. Given below are two statements : one is labelled as Assertion (A) and the other is labelled as Reason (R).

Assertion (A) : During pregnancy the level of thyroxine is increased in the maternal blood.

Reason (R) : Pregnancy is characterised by metabolic changes in the mother.

In the light of the above statements, choose the most appropriate answer from the options given below :

1. Both (A) and (R) are correct and (R) is the correct explanation of (A)
2. Both (A) and (R) are correct but (R) is not the correct explanation of (A)
3. (A) is correct but (R) is not correct
4. (A) is not correct but (R) is correct

182. Select the Incorrect statements with respect to Cyclostomes :

- (a) They lack scales and paired fins.
- (b) They have circular mouth with Jaws.
- (c) They bear 6-15 pairs of gills.
- (d) They migrate to deep sea for spawning.

Choose the most appropriate answer from the options given below :

1. (a) and (b) only
2. (b) and (c) only
3. (b) and (d) only
4. (a) and (d) only

183. Role of enamel is to :

1. Connect crown of tooth with its root.
2. Masticate the food.
3. Form bolus.
4. Give basic shape to the teeth

184. Choose the correct statements :

- (a) Bones support and protect softer tissues and organs
- (b) Weight bearing function is served by limb bones
- (c) Ligament is the site of production of blood cells.
- (d) Adipose tissue is specialised to store fats.
- (e) Tendons attach one bone to another.

Choose the most appropriate answer from the options given below :

1. (a), (b) and (d) only
2. (b), (c) and (e) only
3. (a), (c) and (d) only
4. (a), (b) and (e) only

185. Bivalent or Tetrad formation is a characteristic feature observed during :

1. Synaptonemal complex in zygotene stage
2. Chiasmata in Diplotene stage
3. Synaptonemal complex in Pachytene stage
4. Chiasmata in zygotene stage

Biology - 2 - Section B

186. Which of the following are true about the taxonomical aid 'key' ?

- (a) Keys are based on the similarities and dissimilarities.
- (b) Key is analytical in nature.
- (c) Keys are based on the contrasting characters in pair called couplet.
- (d) Same key can be used for all taxonomic categories.
- (e) Each statement in the key is called Lead.

Choose the most appropriate answer from the options given below :

1. (a), (b) and (c) only
2. (b), (c) and (d) only
3. (a), (b), (c) and (e) only
4. (a), (c), (d) and (e) only

187. A normal girl, whose mother is haemophilic marries a male with no ancestral history of haemophilia. What will be the possible phenotypes of the offsprings ?

- (a) Haemophilic son and haemophilic daughter.
- (b) Haemophilic son and carrier daughter.
- (c) Normal daughter and normal son.
- (d) Normal son and haemophilic daughter.

Choose the most appropriate answer from the options given below :

1. (a) and (b) only
2. (b) and (c) only
3. (a) and (d) only
4. (b) and (d) only

188. IUDs are small objects made up of plastic or copper that are inserted in the uterine cavity. Which of the following statements are correct about IUDs ?

- (a) IUDs decrease phagocytosis of sperm within the uterus.
- (b) The released copper ions suppress the sperm motility.
- (c) IUDs do not make the cervix hostile to the sperm.
- (d) IUDs suppress the fertilization capacity of sperm.
- (e) The IUDs require surgical intervention for their insertion in the uterine cavity.

Choose the most appropriate answer from the options given below :

1. (a), (d) and (e) only
2. (b) and (c) only
3. (b) and (d) only
4. (d) only

189. Refer to the following statements for agarose-gel electrophoresis :

- (a) Agarose is a natural polymer obtained from seaweed.
- (b) The separation of DNA molecules in agarose-gel electrophoresis depends on the size of DNA.
- (c) The DNA migrates from negatively-charged electrode to the positively-charged electrode
- (d) The DNA migrates from positively-charged electrode to the negatively-charged electrode.

Choose the most appropriate answer from the options given below :

1. (a) and (b) only
2. (a), (b) and (c) only
3. (a), (b) and (d) only
4. (b), (c) and (d) only

190. Match List-I with List-II

List-I	List-II
(a) Multipolar neuron	(i) Somatic neural system
(b) Bipolar neuron	(ii) Cerebral cortex
(c) Myelinated nerve fibre	(iii) Retina of Eye
(d) Unmyelinated nerve fibre	(iv) Spinal nerves

Choose the correct answer from the options given below :

	(a)	(b)	(c)	(d)
1.	(iii)	(i)	(iv)	(ii)
2.	(ii)	(iv)	(iii)	(i)
3.	(ii)	(iii)	(i)	(iv)
4.	(ii)	(iii)	(iv)	(i)

191. Excretion in cockroach is performed by all, EXCEPT :

1. Ureose glands
2. Malpighian tubules
3. Fat body
4. Hepatic caeca

192. Select the correct statement regarding mutation theory of evolution.

1. This theory was proposed by Alfred Wallace
2. Variations are small directional changes
3. Single step large mutation is a cause of speciation
4. Large differences due to mutations arise gradually in a population

193. Arrange the following formed elements in the decreasing order of their abundance in blood in humans :

- (a) Platelets
- (b) Neutrophils
- (c) Erythrocytes
- (d) Eosinophils
- (e) Monocytes

Choose the most appropriate answer from the options given below :

1. (c), (a), (b), (e), (d)
2. (c), (b), (a), (e), (d)
3. (d), (e), (b), (a), (c)
4. (a), (c), (b), (d), (e)

194. In the enzyme which catalyses the breakdown of:

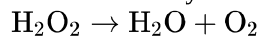

the prosthetic group is :

1. Nicotinamide adenine dinucleotide
2. Haem
3. Zinc
4. Niacin

195. Against the codon 5' UAC 3', what would be the sequence of anticodon on tRNA ?

1. 5' AUG 3'
2. 5' ATG 3'
3. 5' GTA 3'
4. 5' GUA 3'

196. Select the correct statements.

- (a) Angiotensin II activates the cortex of adrenal gland to release aldosterone.
- (b) Aldosterone leads to increase in blood pressure.
- (c) ANF acts as a check on renin-angiotensin mechanism.
- (d) ADH causes vasodilation.
- (e) Vasopressin is released from adenohypophysis.

Choose the most appropriate answer from the options given below :

1. (a), (b) and (e) only
2. (c), (d) and (e) only
3. (b), (c) and (d) only
4. (a), (b) and (c) only

197. With respect to metaphase, which of the following statements is incorrect ?

1. Complete disintegration of nuclear envelope takes place
2. Chromosomes are highly condensed
3. Metaphase chromosomes are made up of four sister chromatids held together by centromere
4. Chromosomes lie at the equator of the cell

198. Select the incorrect statement with respect to inbreeding of animals.

1. It is used for evolving pure lines in cattle.
2. It helps in accumulation of superior genes and elimination of less desirable genes.
3. It decreases homozygosity.
4. It exposes harmful recessive genes that are eliminated by selection

199. Match List-I with List-II

List-I	List-II
(a) Cellular barrier	(i) Interferons
(b) Cytokine barrier	(ii) Mucus
(c) Physical barrier	(iii) Neutrophils
(d) Physiological barrier	(iv) HCl in gastric juice

Choose the correct answer from the options given below

- (a) (b) (c) (d)
- (ii) (iii) (iv) (i)
 - (ii) (iii) (i) (iv)
 - (iii) (iv) (ii) (i)
 - (iii) (i) (ii) (iv)

200. If A and C make 30% and 20% of DNA, respectively, what will be the percentage composition of T and G ?

- T : 20%, G : 30%
- T : 30%, G : 20%
- T : 30%, G : 30%
- T : 20%, G : 20%